

Collaborative Workplace

Office Seating

Height-adjustable
Desks & Workstations



Product Brochure

Seating Collection

Height-adjustable Workstations

—

www.wpdesign.gmbh

A better way to work?

Stay on your feet! Active working is a better way to work. Not only does it create a healthier and more interactive workplace, **it also promotes a more balanced lifestyle.**

Based on many scientific studies, we know that it is beneficial to alternate between sitting and standing throughout long hours of work.



Better in so many ways

We offer **quality that you can trust.**

We build our sit-stand desks with steel tubes that are cold-drawn 3 times to ensure precision and consistency. They are produced with high-precision and fully automated laser-cutting machines. This non-contact and controlled production process creates minimal to almost-zero production tolerance.





KOPLUS

KOPLUS



Hop

Hop is the perfect addition to any modern office set up. **This elegant sit-stand desk will keep you moving** and turn any space into an active workplace.

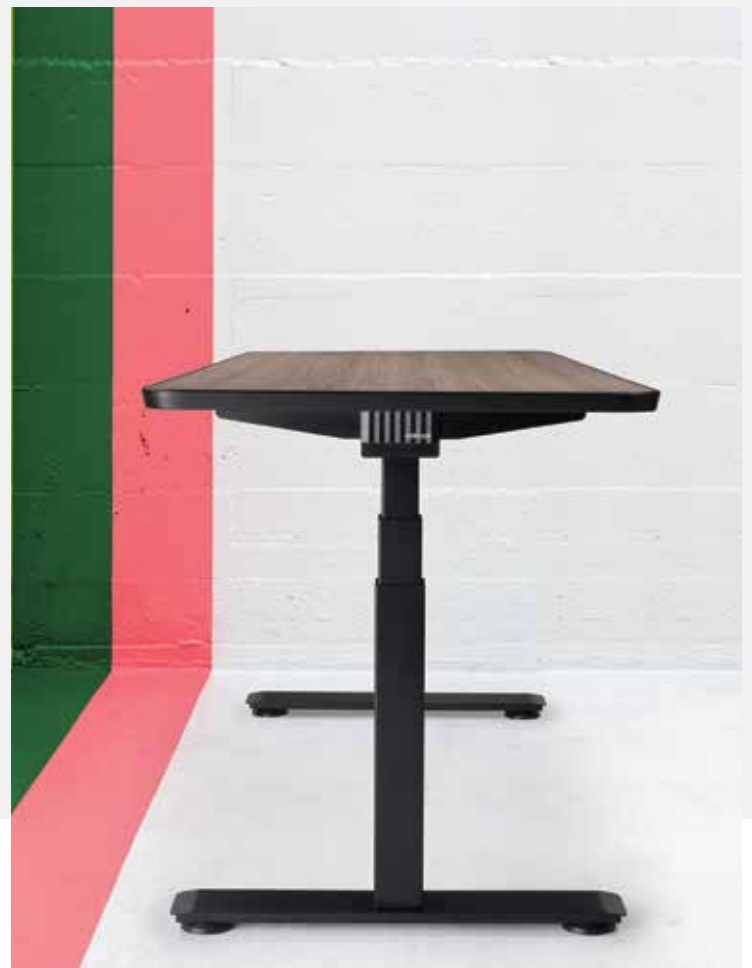

Frame Colour Selection

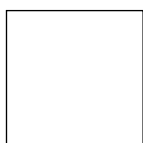



Kin

We are not meant to remain seated for long hours. **To stay healthy and productive, it is important to lead an active life.** We wanted to bring movement back to the office so we designed a collection of stylish sit-stand desks that allows people to easily transition between sitting and standing positions.



Frame Colour Selection





Knest

A workplace isn't just a space where people need to go for work but where they want to be to chase their dreams.

Make a bold statement with Knest's vibrant colour selection.



Frame Colour Selection

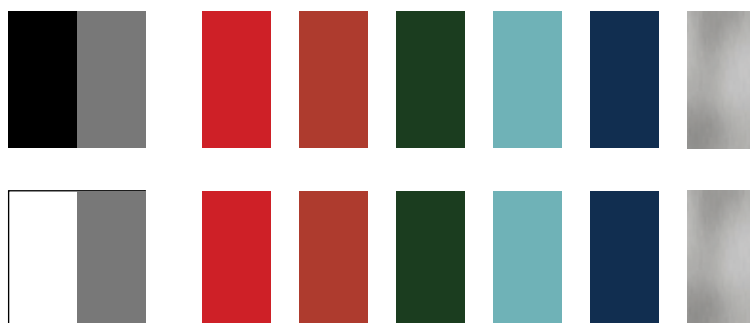

Mount

Work collaboratively with Mount.
As we work, interact and socialize together, we learn more about each other's motivations and ideas..



Frame Colour Selection

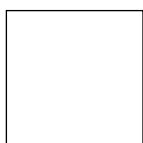



Specifications

- 1 Dual Motor System - Tailored for Sit-stand Desks**
- 2 Anti-collision Mechanism**
- 3 Four Memory Settings**
- 4 Heavy-load Motors**
- 5 Maximum Stability**
- 6 Compact Packaging**
- 7 Easy Assembly**

Adjustable Height Range	650-1300	mm
Height Adjustment Speed	31	mm/sec
Motor Noise	< 52	dB
Recommended Function Load	91	kg
Maximum Weight Loading	136	kg
Levelling Adjustments	50	mm

Power Consumption (when lifting 80 kg)		
Maximum When Operating	280	W
Maximum When Static	0.7 - 0.8	W

Input Voltage	24 - 32	VAC
Nominal Output Voltage	32	VDC
Nominal Output Current	4	A
Overload Protection Threshold	> 6.5	A

Material		
Desk Frame	High-tension Steel	-
Adjustable Leg: Outer Tube	75 x 254	mm
Adjustable Leg: Center Tube	65 x 475	mm
Adjustable Leg: Inner Tube	55 x 470	mm

Hop

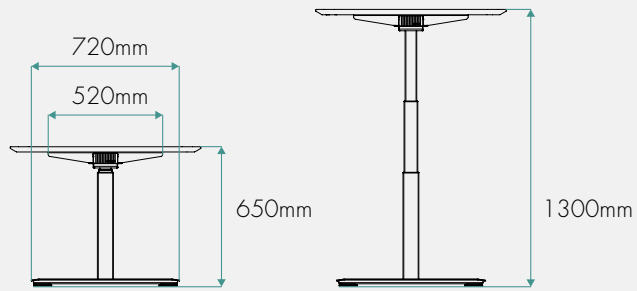
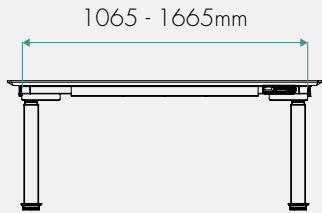

Dual-motor system
Anti-collision mechanism
Telescopic desk frame
Cable management tray

Kin

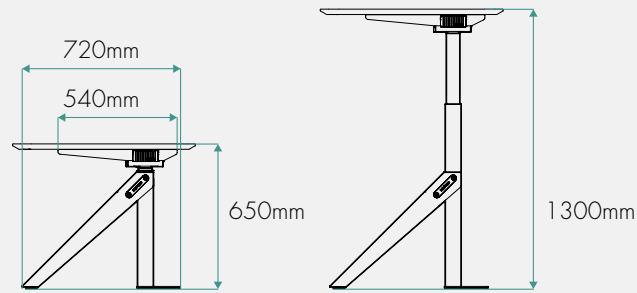
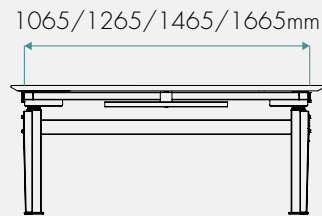

Dual-motor system
Anti-collision mechanism
Cable management tray

Knest

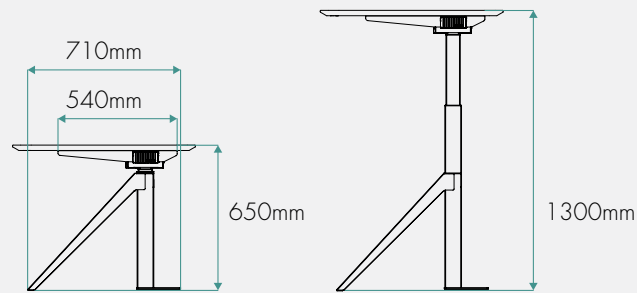
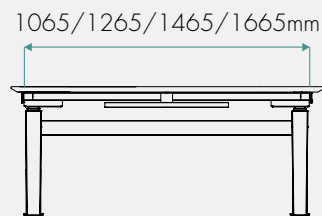

Dual-motor system
Anti-collision mechanism
Cable management tray

Mount

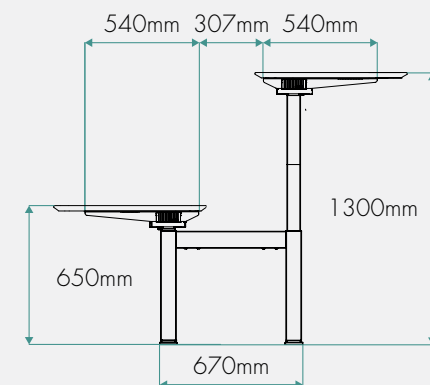
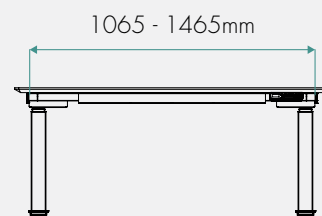

Dual-motor system
Anti-collision mechanism
Cable management tray
Central cable management box

wpdesign.gmbh

KOPLUS[®]
sustainable workplace furniture